

KENWOOD

excelon

KFC-XW12dB

KFC-XW10dB

SUBWOOFER
INSTRUCTION MANUAL

SUBWOOFER
MODE D'EMPLOI

SUBWOOFER
MANUAL DE INSTRUCCIONES

ENGLISH

FRANÇAIS

ESPAÑOL

KENWOOD CORPORATION

IMPORTANT SAFEGUARDS

! Caution : Read this page carefully to keep your safety.

AVERTISSEMENTS IMPORTANTS

! Attention : Lire attentivement cette page pour votre sécurité.

AVISOS IMPORTANTES

! Precaución: Para su seguridad, lea con atención esta página.

1. **Suffocation** — After taking the unit out of the polyethylene bag, be sure to dispose of the polyethylene bag out of the reach of children. Otherwise, they may play with the bag, which could cause hazard of suffocation.

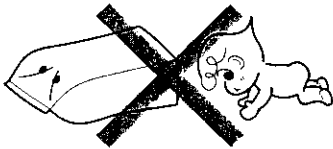

2. **Water and moisture** — Do not install the speakers in locations which may be subject to water or moisture.

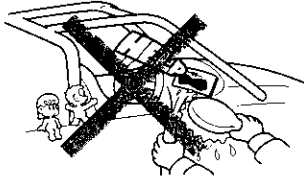

3. **Dust and unstable locations** — Do not install the speakers in unstable locations or locations subject to dust.

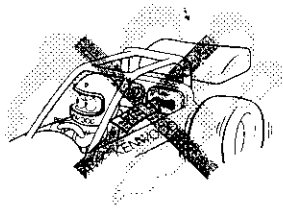

4. **Modification** — Do not attempt to open or modify the unit, for this could cause fire hazard or malfunction.

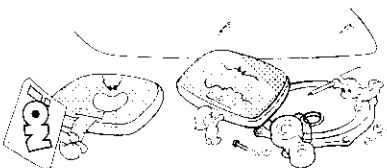

Etouffement — Après avoir retiré l'appareil du sac de polyéthylène, bien placer ce dernier hors de la portée des enfants. S'ils jouent avec ce sac, un risque d'étouffement est possible.

Asfixia — Después de sacar la unidad de la bolsa de polietileno, asegúrese de poner la bolsa de polietileno donde no puedan alcanzarla los niños. De otra forma, éstos podrían jugar con la bolsa y se podría producir un peligro de asfixia.

Eau et humidité — Ne pas installer les haut-parleurs dans des endroits où ils peuvent être exposés à de l'eau ou à l'humidité.

Agua y humedad — No instale los altavoces en lugares sometidos al agua o a la humedad.

Poussière et endroits instables — Ne pas installer les haut-parleurs dans des endroits instables ou exposés à de la poussière.

Polvo y ubicaciones inestables — No instale los altavoces en lugares inestables ni en lugares donde haya polvo.

Modification — Ne pas essayer de démonter ni de modifier l'appareil car ceci risque de provoquer un risque d'incendie ou un fonctionnement incorrect.

Modificación — No trate de abrir ni modificar a unidad porque podría producirse un peligro de incendio o una avería.

5. **Cleaning** — Do not use gasoline, naphtha, or any type of solvent to clean the speakers. Clean by wiping with a soft, dry cloth.

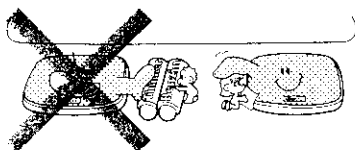

6. **Abnormal smell** — In the event the unit generates smoke or abnormal smell, immediately switch the power OFF. After this, please contact your dealer or nearest service station as soon as possible.

POWER OFF!

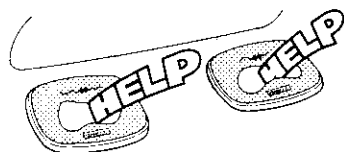

Nettoyage — Ne pas utiliser d'essence, de naphthé ni de diluant pour nettoyer les haut-parleurs. Les nettoyer avec un chiffon doux et sec.

Limpieza — No utilice gasolina, nafta ni ningún otro tipo de disolvente para limpiar los altavoces. Límpielos con un paño suave y seco.

Odeur anormale — Dans le cas où l'appareil produit de la fumée ou une odeur anormale, couper immédiatement l'alimentation. Contacter ensuite votre concessionnaire ou centre de service le plus proche le plus rapidement possible.

COUPER L'ALIMENTATION!

Olor anormal — En el caso de que la unidad genere humo o un ruido anormal, desconecte inmediatamente la alimentación. Después, consulte con su concesionario o centro de reparaciones más cercano tan pronto como sea posible.

DESCONECTE LA ALIMENTACION!

Note:

Observe the following cautions to prevent damage the speakers.

- When the volume is set too high, sound may be distorted or abnormal. Reduce the volume promptly in case of such phenomena.
- While the listening volume is set to a high level, do not load or eject a disc or cassette tape or operate the selector and power switches of the amplifier.

Remarque:

Respecter les consignes suivantes pour éviter que les enceintes ne soient endommagées.

- Si le niveau de sortie est trop puissant, les sons peuvent être déformés ou anormaux. Réduire le niveau de sortie aussitôt que l'on constate ce phénomène.
- Si le niveau de sortie a été réglé à une valeur élevée, ne pas mettre en place ou éjecter un disque ou une cassette, ne pas agir sur les sélecteurs ou l'interrupteur d'alimentation de l'amplificateur.

Nota:

Tome las precauciones siguientes para evitar estropear los altavoces.

- Cuando ajuste un volumen demasiado alto, el sonido podrá distorsionarse o no ser normal. Reduzca rápidamente el volumen en este caso.
- Mientras el volumen de escucha esté ajustado a un nivel alto, no introduzca ni expulse un disco o un casete, ni utilice los selectores ni el interruptor de la alimentación del amplificador.

Greeting

Dear Customer,

Congratulations on your choice of a Kenwood dB+ Subwoofer. Kenwood is known world-wide for producing some of the most advanced car audio products on the market, and our new dB+ Subwoofer is the result of the latest research in speaker technology. Installed properly, your dB+ Subwoofer will do just what the name says: it will boost the decibel level of your system's low frequency response.

You can install your dB+ Subwoofer in a sealed or ported enclosure with excellent results. Your choice will depend on the kind of bass sound you like best. On pages 16-17, we show you the different kinds of bass sound that you'll get from different sizes and styles of enclosures.

Design Features

- **PBO Cone -**
PBO is a new high performance fiber that has high rigidity which minimizes distortion.
- **AFC(Advanced Feed Construction) Spider -**
Lead wires are stitched onto the spider limiting lead wire movement and eliminating noise.
- **Spiral Vented Pole Piece -**
Spiral shape improves airflow which helps control the pressure behind the cone for a stronger bass response.
- **Designed Thick Basket -**
1.2mm thick, high rigidity basket reduces distortion.
- **One piece Rubber Surround and Gasket -**
Reduces vibration of basket and thus reduces noise.
- **52oz(12")/42.3oz(10") Strontium Magnet -**
Produces stronger and more powerful bass.
- **Extended Pole Piece -**
Improved magnetic flux reduces distortion at higher wattages.
- **Long Throw Voice Coil and Bumped Back Plate -**
Improves linearity of movement giving wider range and higher output.
- **Black Painted Pole Piece and Top Plate -**
Improved heat emission.
- **Gold Plated SB Speaker Terminal -**
Designed for multiple connection methods specifically for thick/high quality speaker cables which lead to good signal transmission.

Dimensions

■ KFC-XW12dB

■ KFC-XW10dB

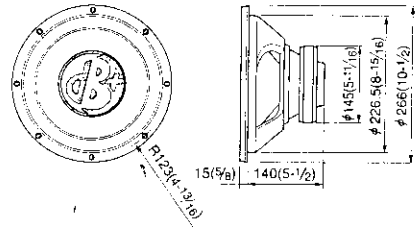
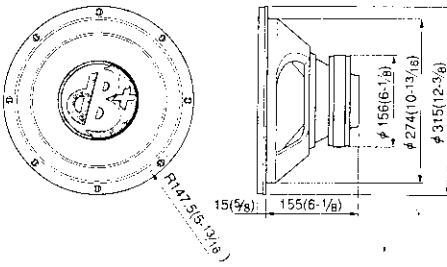

ENGLISH

Specifications

| | KFC-XW12dB | KFC-XW10dB |
|---------------------------|----------------------------------|----------------------------------|
| Subwoofer | 300 mm (12") PBO Cone type | 250 mm (10") PBO Cone type |
| Nominal Impedance | 4 Ω | 4 Ω |
| Peak Input Power | 1,000 W | 800 W |
| Rated Input Power | 250 W | 200 W |
| Sensitivity | 93 dB/W at 1 m | 92 dB/W at 1 m |
| Free Air Resonance | 19.3 Hz | 24.4 Hz |
| Frequency Response | 23 Hz ~ 600 Hz | 25 Hz ~ 600 Hz |
| Dimensions | | |
| Diameter | 315 mm (12-3/8") | 266 mm (10-1/2") |
| Depth | 170 mm (6-11/16") | 155 mm (6-1/8") |
| Mounting Depth | 155 mm (6-1/8") | 140 mm (5-1/2") |
| Net Weight | 5,500 g | 4,400 g |
| Supplied Parts | Screw ø 4 - 25 × 8 Spacer × 1 | Screw ø 4 - 25 × 8 Spacer × 1 |

Building the Enclosure

1. Select the type and size of the enclosure of your choice from the performance charts on pages 16-17.
2. Determine the internal length, width, and depth of the enclosure. Caution: Make sure the mounting depth of the subwoofer fits into the dimensions of your enclosure and make sure the box fits in the desired position in your vehicle. KENWOOD recommends a cubic shape, however same length sides cause resonance due to standing waves so it's better to slightly change the lengths.

| |
|---|
| Internal Enclosure Volume (Cu.ft) = $\frac{\text{Height (inch)} \times \text{Width (inch)} \times \text{Depth (inch)}}{1728}$ |
|---|

3. Cut wood, taking into account the thickness of the material being used. We recommend using MDF(Medium Density Fiberboard) or HDP(High Density Particleboard). We also recommend using a table saw for straight cuts to prevent air leakage once assembled.
4. Assemble enclosure. Use glue when assembling the sides of the enclosure.
5. Cut hole(s) in the baffle board. Use a template to make the subwoofer hole the appropriate size.
6. Seal enclosure using silicon or siliconized caulk on the internal seams.
7. Bring speaker cables into enclosure through rear of enclosure. Make sure to seal the speaker cable hole or terminal cup.
8. Stuff damping material such as dacron or fiberglass inside the enclosure.

Installation

1. Attach the included gasket tape to the back of the speaker flange as shown in Fig.1 so that the flange is completely covered.
2. Attach the speaker cables to the SB speaker terminals by the method of your choice.
3. Complete installation by installing subwoofer into enclosure with the provided screws.

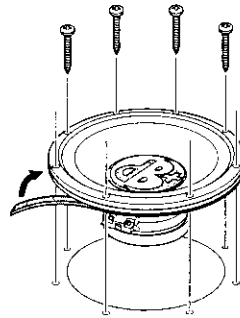

Fig. 1

System Connections

First, check the power of the amplifier. If the power of amplifier is higher than the subwoofer's rated input power, increase the number of subwoofers so that the power per subwoofer is lower than the rated input power, or lower the sensitivity of the amplifier. Supplying power greater than the rated input power of the subwoofer will cause noise and/or breakage. Also, if using multiple subwoofers, be careful about the total impedance. Change the connecting pattern of the speakers according to the capable impedance of the amplifier.

■ Series Wiring

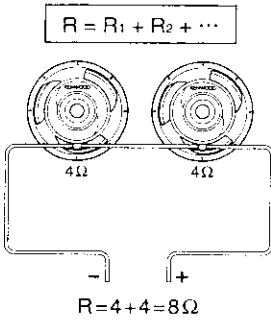

Fig. 2

■ Parallel Wiring

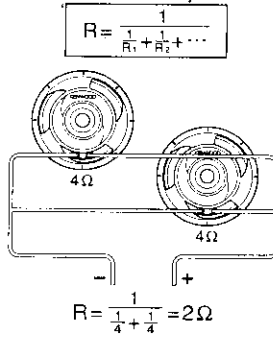

Fig. 3

■ Series-Parallel Wiring

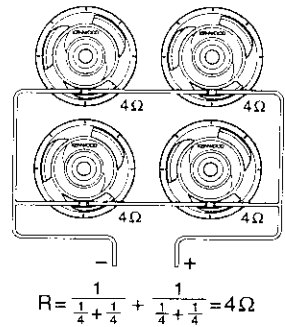

Fig. 4

Use a crossover network of your choice with an appropriate cutoff frequency.

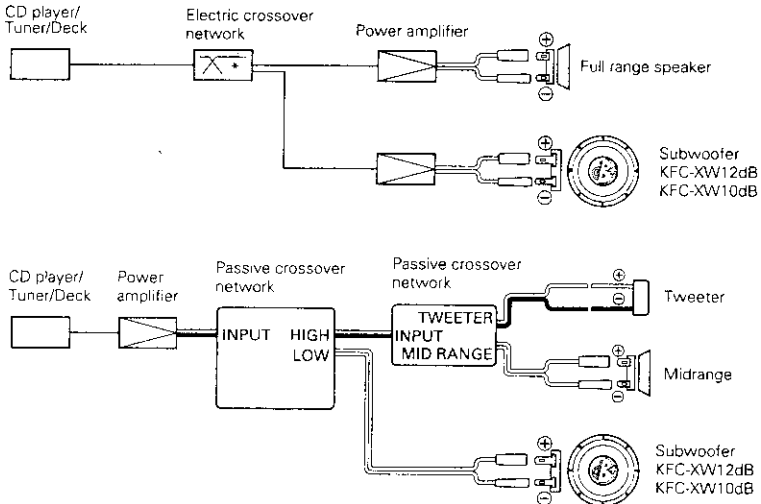

Fig. 5